

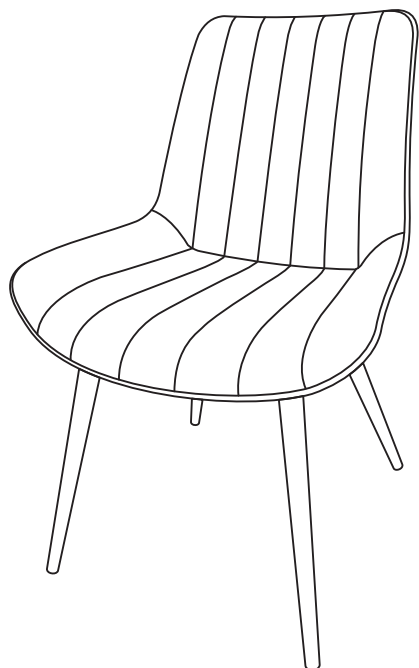







CF-DC254

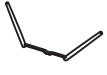

A		1
B		1
C		1
D	 M6x35mm	1
E	 M6x45mm	4
F	 M6x16mm	5
G	 M5	1

1.

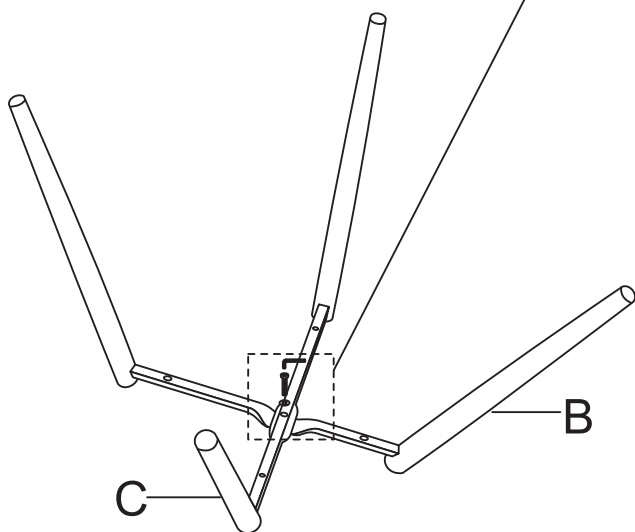
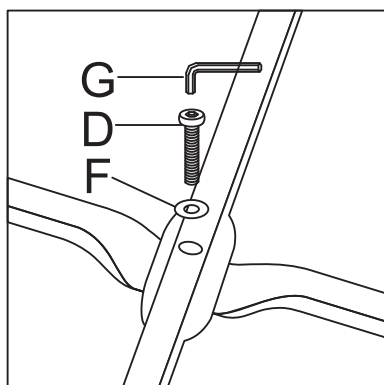

2.

